

Schiebetastenschalter von oben gesehen

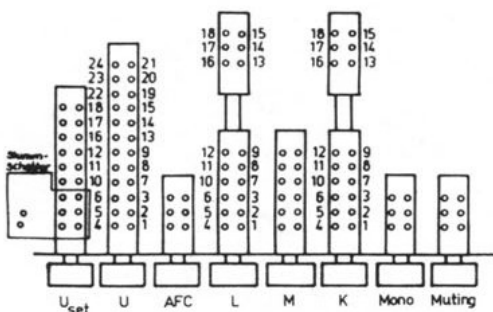

Schaltkreise auf die Anschlüsse gesehen

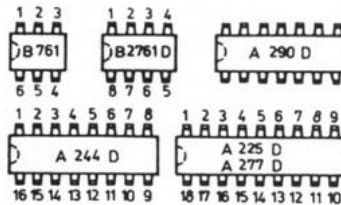

Spulen, Filter, Halbleiterbauelemente auf die Anschlüsse gesehen

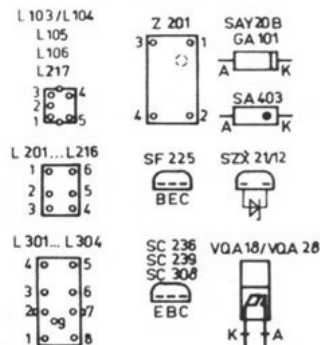

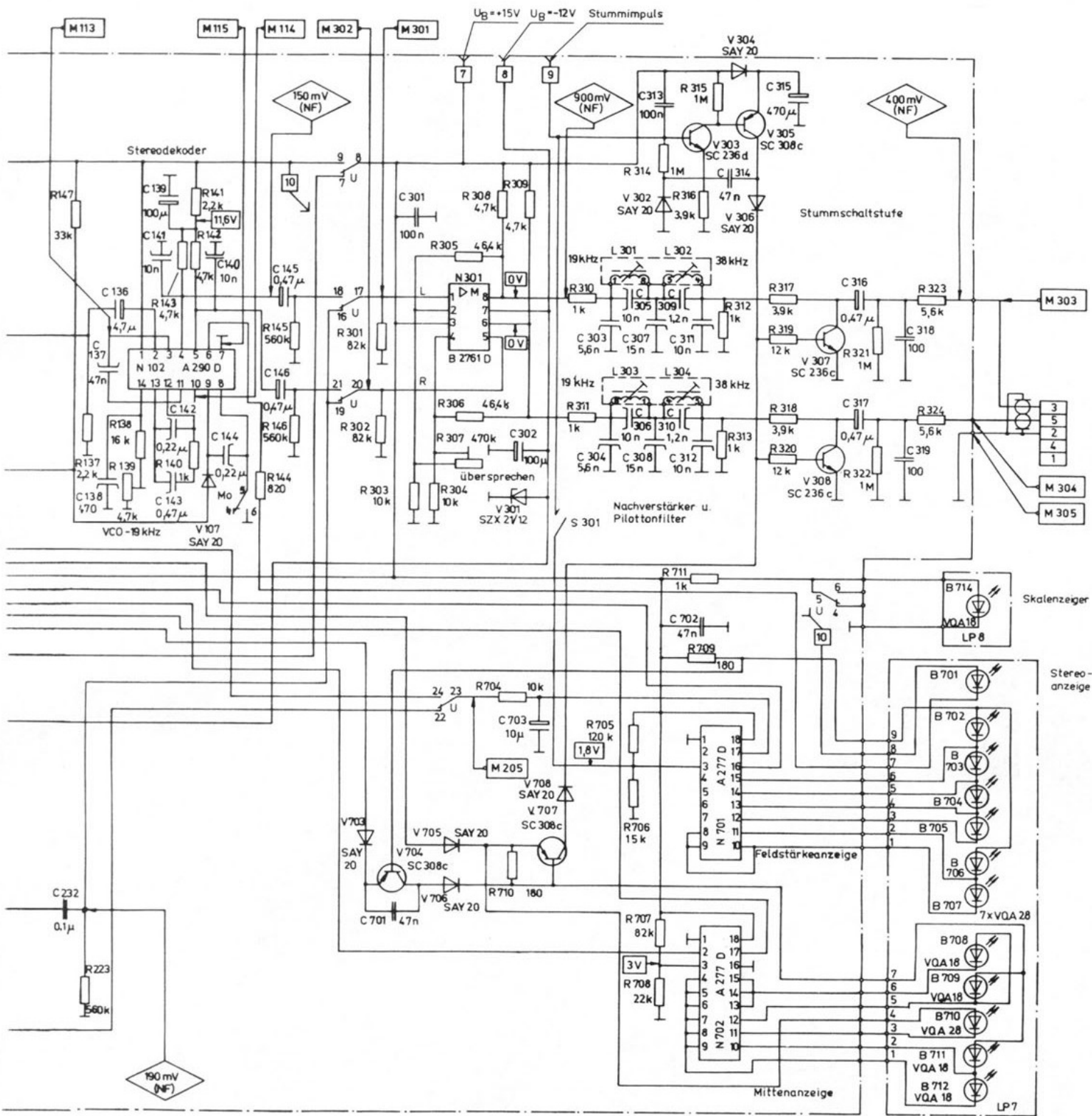

Halbleiterbauelemente
auf die Anschlüsse gesehen

- SC 236
- SC 237
- SC 307
- BEC
- SA 403
- MAA 550
- B 3170 V
- U 7100/U 7110
- U 7100/U 7110
- 1 2 3 4 5 6 7 8
- 1 2 3 4
- 16 15 14 13 12 11 10 9
- 8 7 6 5
- VDA 18 / VDA 28
- VDA 26
- VDA 26

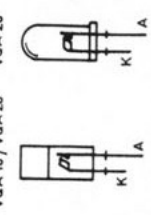
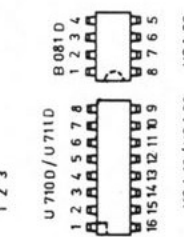
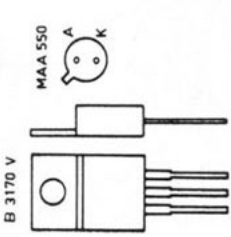

Schiebelastenschalter
von oben gesehen



Abstimmpotentiometer
für Skala
R 900

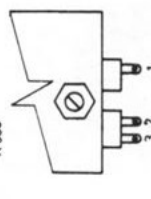

für Programmspeicher
R 922...R 928

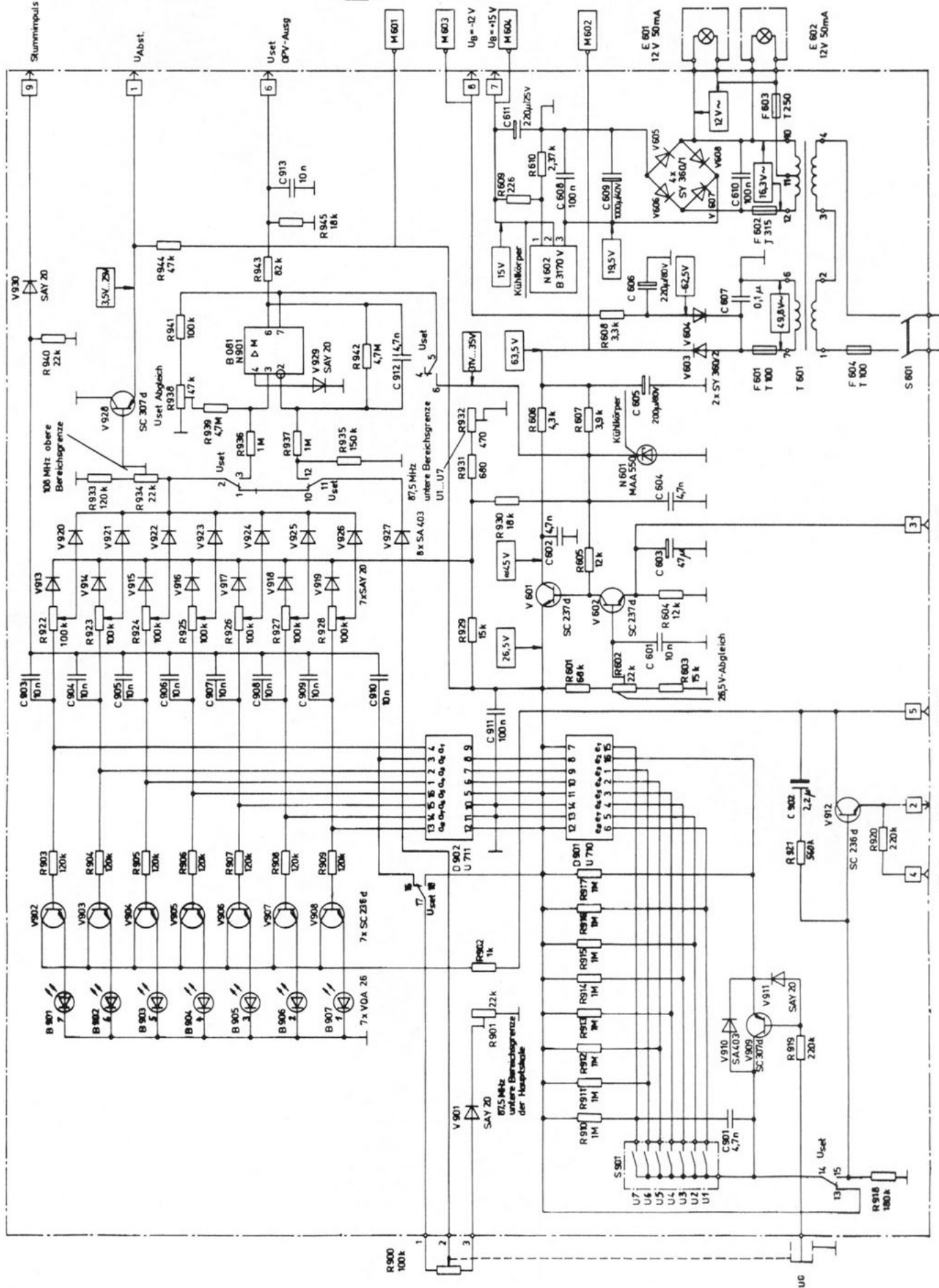
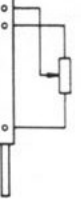

Spannungen mit Instrument R_i ≥ 100 kΩ/V gemessen

AFC-50mV

UG FM +15V

AFC-aus

U_{set} +15V

Fortsetzung von Seite 173